

SUPERPLAN

- exclusive, elegant design
- with a depth of 2,5 cm, extremely flat and ideally suited for floor level installation
- made of KALDEWEI steel enamel
- flush-fitting recessed waste cover
(only in combination with the KA 90 waste fittings)



Similar illustration

	Combined Tray & Waste depth	Waste fitting depth
KA 90	105	81
KA 90 extra flat	94	70
KA 90 ultra flat	85	61
KA 90 vertical	49	81

See page 275.

Model 386 with support

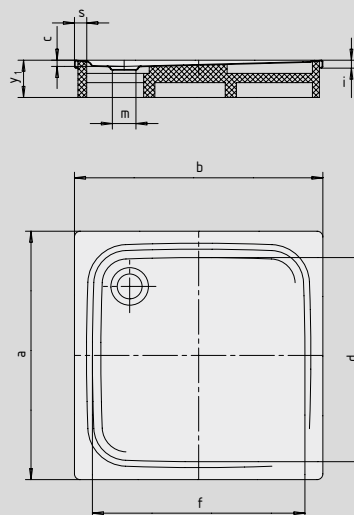

Model 400 with support

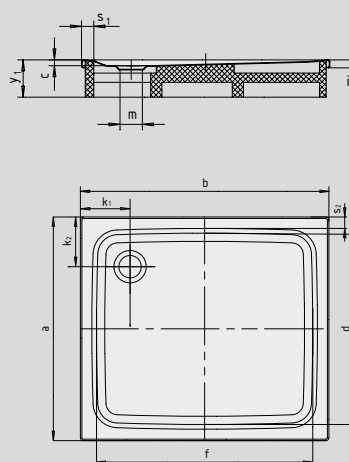

SECURE⁺

Model No.		385	386	400
External length	a	750	800	700 mm
External width	b	800	800	900 mm
Depth	c	25	25	25 mm
Internal length	d	650	690	600 mm
Internal width	f	700	690	800 mm
Height of rim	i	32	32	32 mm
Distance tray edge to centre of drain hole	k	200	200	200 mm
Diameter of drain hole	m	90	90	90 mm
Width of rim	s	50	50	50 mm
Height with support	y ₁	120	120	120 mm
Weight of the enamelled shower tray in kg		17	18	18
Anti-slip		Ø 435	Ø 435	Ø 435 mm
Full anti-slip		524 x 565	586 x 565	461 x 673 mm
SECURE PLUS		all-over	all-over	all-over

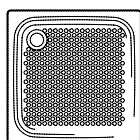

The TÜV Rheinland confirms the following properties of KALDEWEI's anti-slip, full anti-slip and SECURE PLUS finish:

- Assessment group **B** for wet barefoot areas (**DIN 51097**)
- Assessment group **R 10** for slip-resistant properties in work rooms and areas with an increased risk of slipping (**DIN 51130**)

All SUPERPLAN models are available either with anti-slip, full anti-slip or SECURE PLUS.

Model 399 with full anti-slip or SECURE PLUS fits DIN barrier-free 18040-2.